

SNS seminarium 180123



Karolinska
Institutet

Effektivare hivprevention i teori & praktik



Anna Mia Ekström, professor
Karolinska Institutet &
Karolinska Universitetssjukhuset
Global & Sexual Health Research group (GloSH)
<http://ki.se/en/phs/global-and-sexual-health>

37 miljoner människor lever med hiv i världen

Afrika söder om Sahara är oproportionerligt hårt drabbat



Statlig finansiering av hälsovård (omvänt behovet)



Karolinska
Institutet

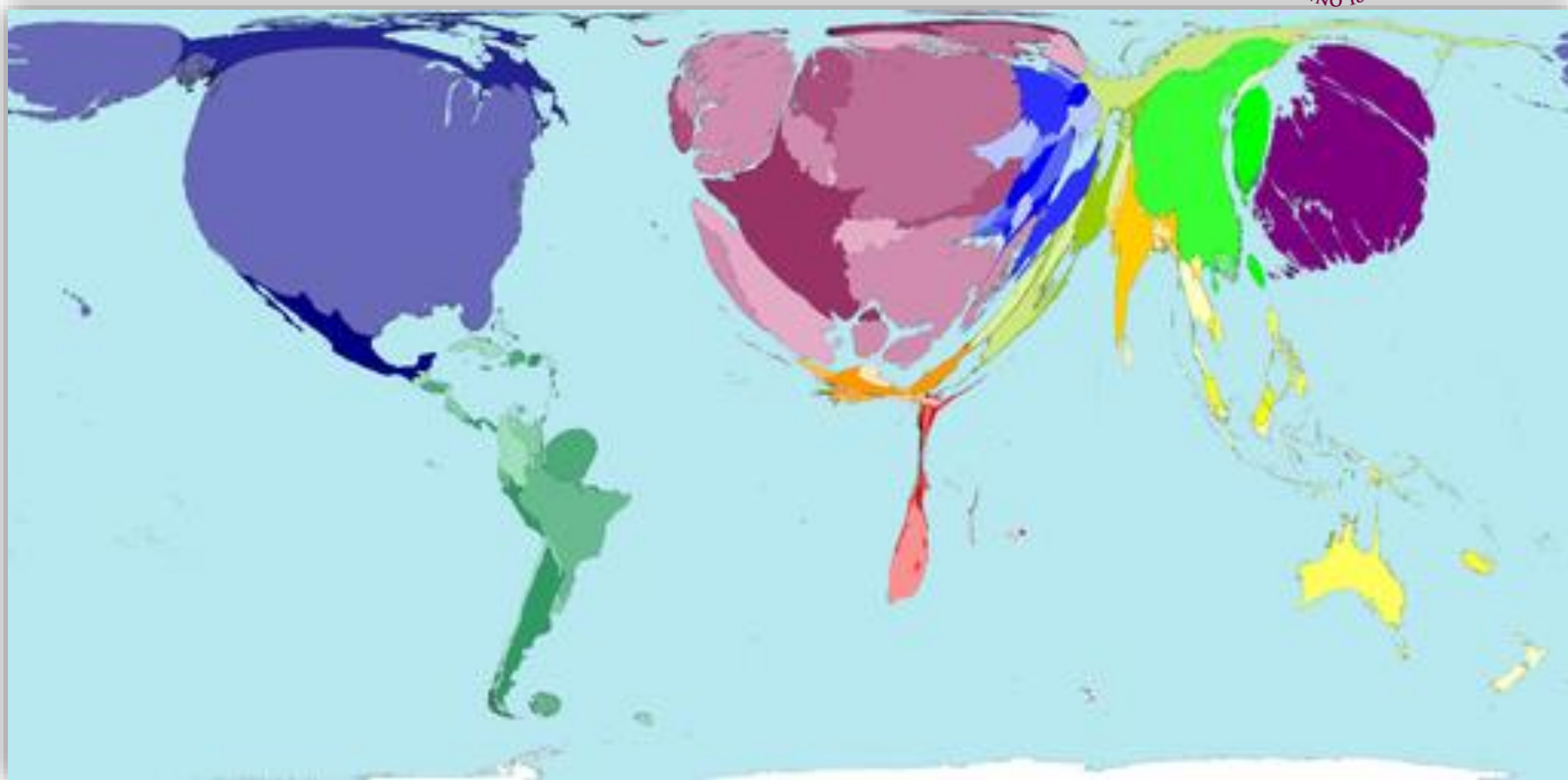

”The availability of good medical care tends to vary inversely with the need for it in the population served.”

(Hart J.T., Lancet)

Stor sjukdombörda- # nya hiv-infektioner måste minska

- 37 miljoner lever med hiv
- 5000 smittas/dag (1.8 miljoner/år)
→ 2/3 i Afrika söder om Sahara
- 3000 dör/dag (1 miljon/år)
- 4 av 10 nysmittade <25 år
- >10 miljoner vet inte om sin hiv
- FNs 90-90-90 mål för 2020

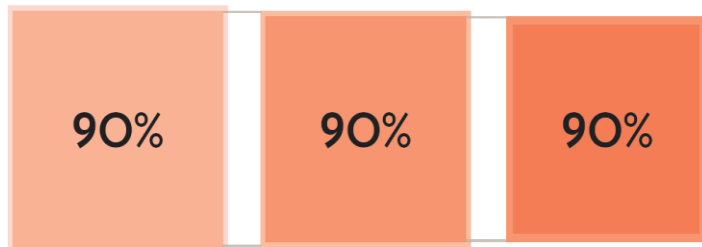

of people living with HIV know their status

of people living with HIV who know their status are on treatment

of people on treatment are virally suppressed

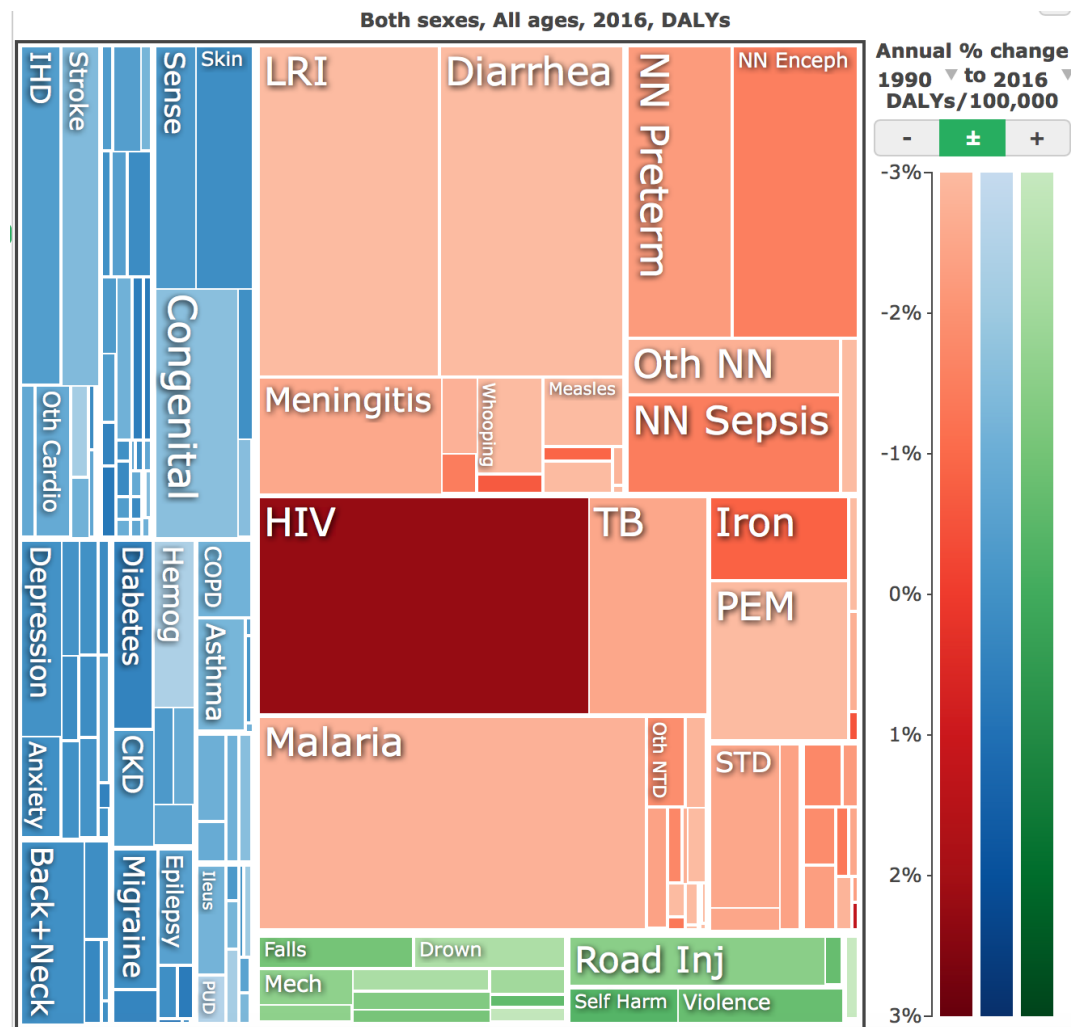

Hiv-preventiva åtgärder

- Minska risken med biomedicinska insatser

- **TasP treatment as prevention!!***

- PMTCT prevention av mor-barn smitta

- PreP pre-exponeringsprofylax

- Manlig omskärelse

- *Vaccin?*

- Minska riskbeteendet

- Säkrare sex- ABC

- Cash transfers

- *Lotteri* → kan öka motivationen att ändra riskbeteende

- → *Skräddarsydd prevention för högriskindivider (risk lovers)?*



Vilka har högst risk att få hiv i Afrika söder om Sahara?

- *“...många känner till riskerna med oskyddat sex med hiv-positiv partner och väljer att inte utsätta sig för det”*



- Störst risk har minst makt

- 60% är (unga) kvinnor

- “Key populations”

- Sex workers, män som har sex med män (MSM) fishing folks, iv droganvändare (PWIDs)

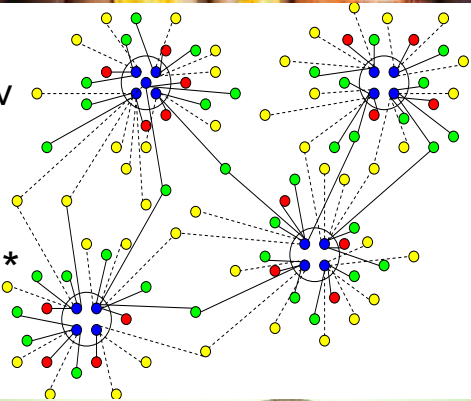

- 80% smittas av någon som inte vet om sin hiv-infektion*

- 50% smittas av nyinfekterad med hög virusnivå

- Sexuella nätverk & parallella partners har betydelse



- “Risk lovers” ? Eller vad styr risk beteende?
- Competing risks
- Discounting/ungdom, “money talks bullshit walks”
- Poor quality of life
- Few alternative life opportunities



Kasensero fishing village, Lake Victoria
Uganda, September 2017
Hivprevalens 40-80%

Begränsade valmöjligheter i livet, transaktions-sex mycket vanligt, hur motiverar man till långsiktighet (utbildning, sparande)..
→ Kan lotteri-interventionen göra det?



Lakeside school/Rakai AIDS orphanage,
Kansensero, Uganda
<https://www.facebook.com/raiduganda/>



Township, Kapstaden, Sydafrika
November 2017
Hiv-prevalens 20-40%

Stigma!! → minskar retention in care (TasP, PMTCT, PreP)

- Begränsade försörjningsalternativ särskilt för kvinnor och barn om partnern/grannarna för veta om hiv
- Vi är sociala varelser: beteende-ekonomi superviktigt!



Svaga hälsosystem försvårar också biomedicinska insatser och tillgången till prevention och behandling

PreP, PMTCT, TasP, Manlig omskärelse

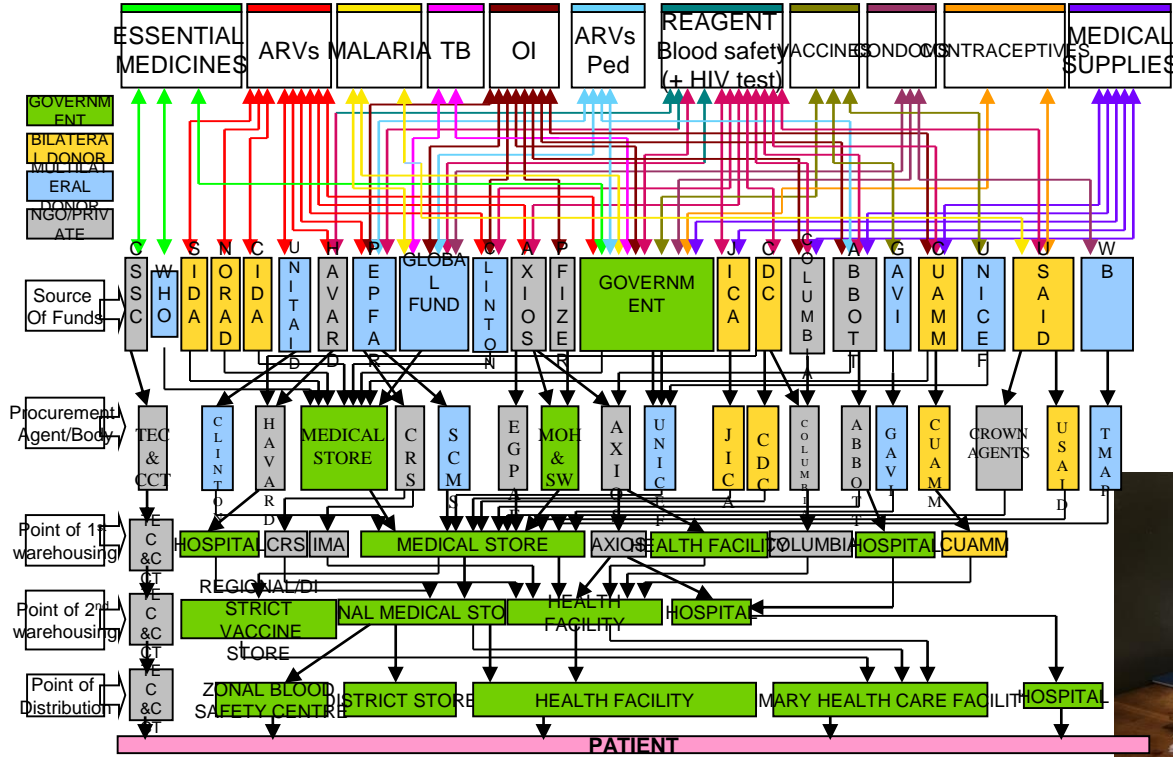

GODA EXEMPEL! Manlig omskärelse

→ minskar hivrisken med 60% hos männen*, Kenya ligger först, skolpojkar omskärs före sexdebut, starkt socialt stöd (etniska, religiösa aspekter)

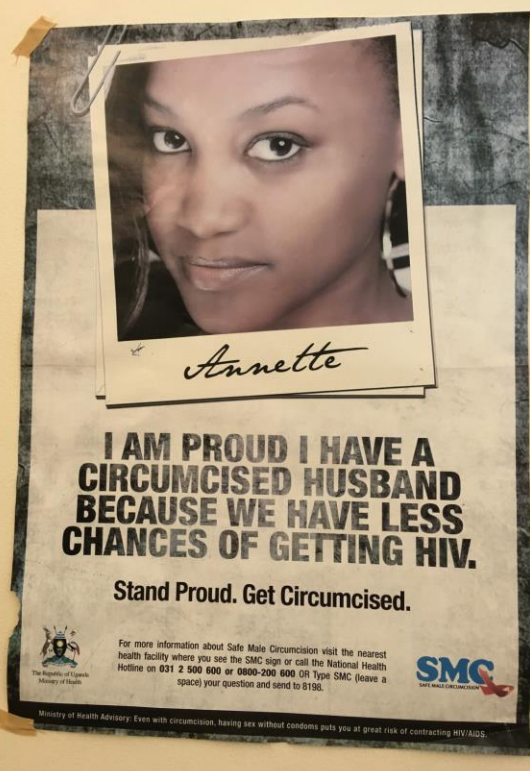

INFORMATIONS-KAMPANJER



Thinking out of the box!

Peers, self-testing, male involvement, mobila enheter, bättre fritidshem, skolor

Larger gaps for young people across the cascade

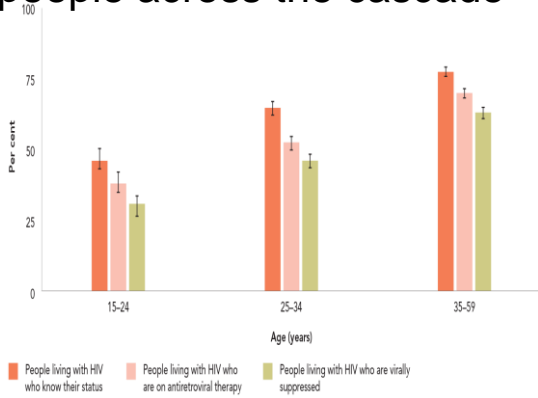

Knowledge Of HIV Status, Treatment Coverage And Viral Load Suppression, Malawi, Zambia And Zimbabwe, BY AGE, 2015-2016

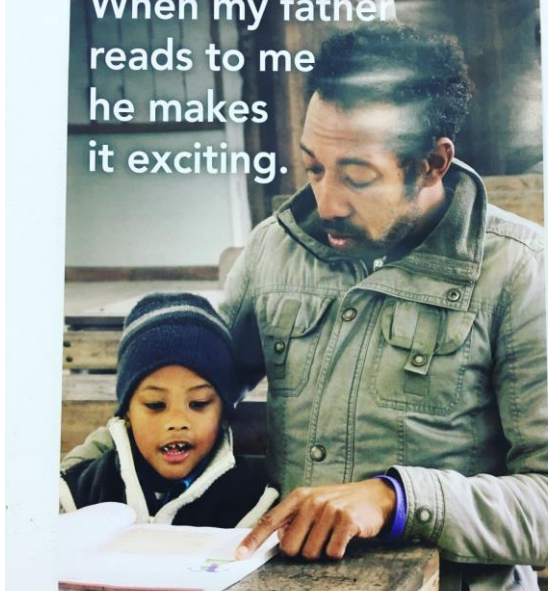

Desmond Tutu HIV Foundation, Kapstaden. November 2017



Potentiell användning i Sverige: Sexuell och reproduktiv hälsa unga migranter i Sverige: hur påverkar upplevd risk och risktagande personlighet riskbeteende?





Karolinska
Institutet



anna.mia.ekstrom@ki.se

[http://ki.se/en/phs/global-and-sexual-health,](http://ki.se/en/phs/global-and-sexual-health)

<https://www.facebook.com/raiduganda/>